

SL 160-13.0

ŽUMPA V=13,0m³

m=6,8t (jímka)
 =2,5t (víko)
 =0,5t (komínek + destička)
 =9,8t (celkem)

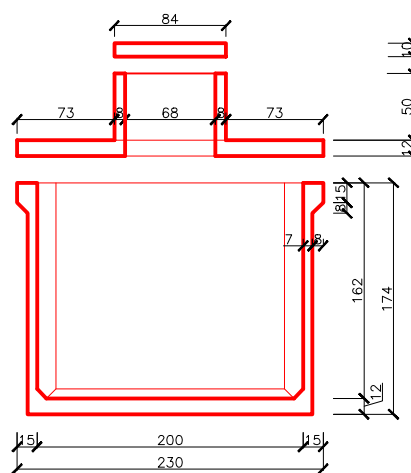
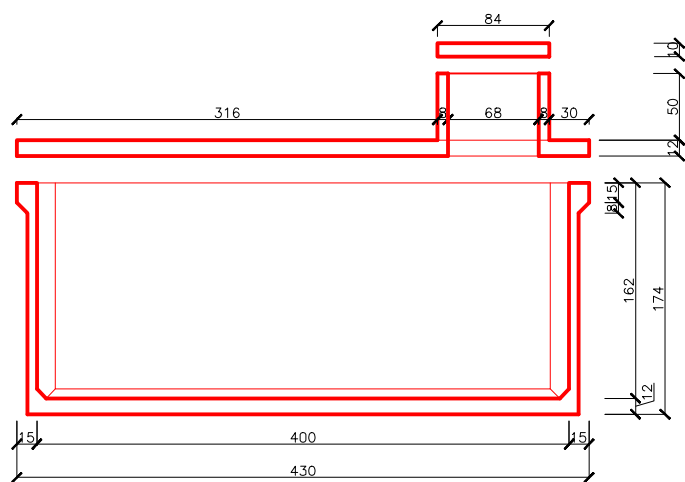
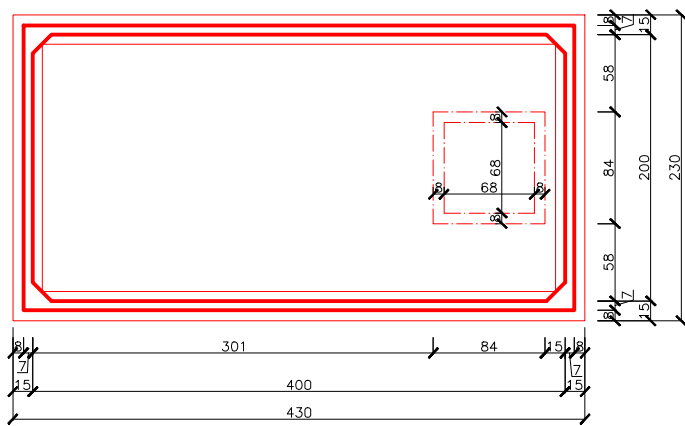
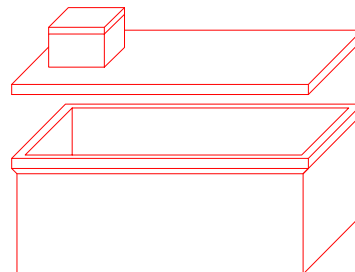

Kreslil	P.Havel	www.septiky-zumpy.cz
Měřítko:	1:50	Prodejce: Septiky, žumpy, jímky, garáže s.r.o. Palachova 51 412 01 Litoměřice
Datum:	11.2009	
Výkres:	SL 160-13.0	